

Rethink

Renew

Reshape

Reimagine

Our journey towards
sustainability

dyson



Foreword

Dyson is built on sustainable principles. At every step, we have focused on solving problems; engineering better technology, using fewer materials and less energy.

First, we removed the bag from the vacuum to prevent loss of suction. This was an engineering decision, but in saying goodbye to the bag, we removed an unnecessary, single-use consumable.

We created a more energy-efficient machine, which contributed to less woven plastic bags going to landfill every year. The vacuum cleaner industry followed us. This is the power that new technology has to change behaviour.

As engineers, we continue to focus on problem-solving and doing more with less. Take the Dyson Digital Motor. The result of more than 15 years of research and development, it is five times lighter than its old-fashioned predecessor and achieves a step change in performance.

The power density of Dyson's motors has increased 25 times from the brushed motor in our first cordless vacuum, to the Digital Motor in our latest cordless machine.

The motor drives our products – drying hands, styling hair, purifying air and cleaning homes, efficiently. Dyson Airblade™ hand dryers, for instance, use 10% of the energy of hot air hand dryers and can dry six pairs of hands for the equivalent embodied carbon in a single paper towel. Dyson Supersonic™ hair dryers dry hair with a powerful airflow, not extreme heat. Our LED lights last for 60 years, meaning no bulb replacements. And our vacuums outperform predecessors, but with less energy, fewer materials, and much less weight.

Engineers are perpetually dissatisfied and want to do better, and we will; there is no end point, only continual improvement. Our competitors copy our every move, so the leaps we are pursuing remain secret. What I can reveal, however, is that through our battery research in Malmesbury and Singapore, we are driving a revolution in new technology, and the same goes for our programmes in robotics, software, material science and filtration.

We have also applied our sustainable approach to how we operate.

The generations of our high-speed Dyson Digital Motors – getting smaller and more efficient over time – have allowed Dyson engineers to fundamentally change the format of vacuums and enter new categories.



We prefer to restore buildings and workspaces, rather than create new ones, and we do so at scale, such as our new Global HQ, St James Power Station in Singapore, and Hullavington Airfield in Wiltshire.

There is no doubt that the world faces some big problems, but we won't solve them by wearing a hair shirt – we need optimism, determination, and an engineering mindset. We also need many more engineers, which is why we launched the Dyson Institute of Engineering and Technology and why the James Dyson Foundation works with schools and universities around the world to inspire future engineers.

We see the optimism that young engineers have for a better future very clearly in the James Dyson Award entries each year. These brilliant young people don't grand-stand, instead they diligently and quietly apply themselves to problem-solving, making great progress as a result.

We also see it at Dyson Farming, where the leading minds in agriculture are developing new methods – and new technology – to produce nutritious food in the future in a more sustainable way. Robotic technology is already supporting our farms and we are working towards a future where materials grown on our farms are used in Dyson's technology.

I highlight these points, not to show off, but to show how a sustainable approach is wired into how we operate – and it always has been. Sustainability may be fashionable now, but it has always been important at Dyson – from the very beginning. We want more problem-solvers to join us on this mission.

James Dyson



Rethink

Products and technology



Removing the bag was the start

In 1993, Dyson invented a vacuum cleaner that proved the plastic vacuum bag was redundant. Made of single-use plastic, these bags were wasteful and inefficient. They reduced suction and the performance the moment you started using them, because their pores would clog with dust. Dyson engineered a new way to clean with the DC01, a vacuum cleaner that separated dust from air using centrifugal forces. It overcame the inefficiency and the poor performance of traditional bagged machines.

In removing the bag, we built expertise in motors, airflow and filtration – fundamental Dyson technologies. We led the way, and others followed our lead.



The motors revolution



Conventional brushed motors consume more electrical energy and generate less mechanical energy because they rely on carbon brushes. This is inherently inefficient because of the frictional forces, release of carbon dust, and limited lifecycle of products as brushes wear down.



The Dyson Digital Motor relies on digital switching, meaning no carbon brushes. Since 2004, Dyson has invested over £350m* into the development and manufacture of 145 million high-speed, efficient motors.

The generations of our high-speed Dyson Digital Motors – getting smaller and more efficient over time – have allowed Dyson engineers to fundamentally change the format of vacuums.

*Amount converted using 2023 budget rate.
Motor imagery for demonstration purposes only.

30 years ago, people thought a bigger product meant faster and more powerful results. But Dyson engineers went against this, channelling engineering effort into high performance machines that are lighter, use less material and resources, but don't compromise on power.

To do this we focused engineering effort and investment on the heart of our products, the Dyson Digital Motor. For more than 15 years and counting, our engineers have relentlessly designed, built and tested our motors to make these small, compact technologies do more for both our products and owners.

Dyson engineers focus on maximising the power density* of the motor. The performance driven from each joule of energy is scrutinised, developing radically smaller, lighter, faster motors to sit at the core of our products, as the graph displays.

Our latest motor achieves a step change in performance while being three times faster and five times lighter than old-fashioned motors; radically improving power density* over iterations of Dyson Digital Motor.

The latest Dyson Digital Motor in the Dyson Gen5detect™ vacuum is 91.5% energy efficient, compared to its carbon brushed predecessor in the region of 70% efficiency.

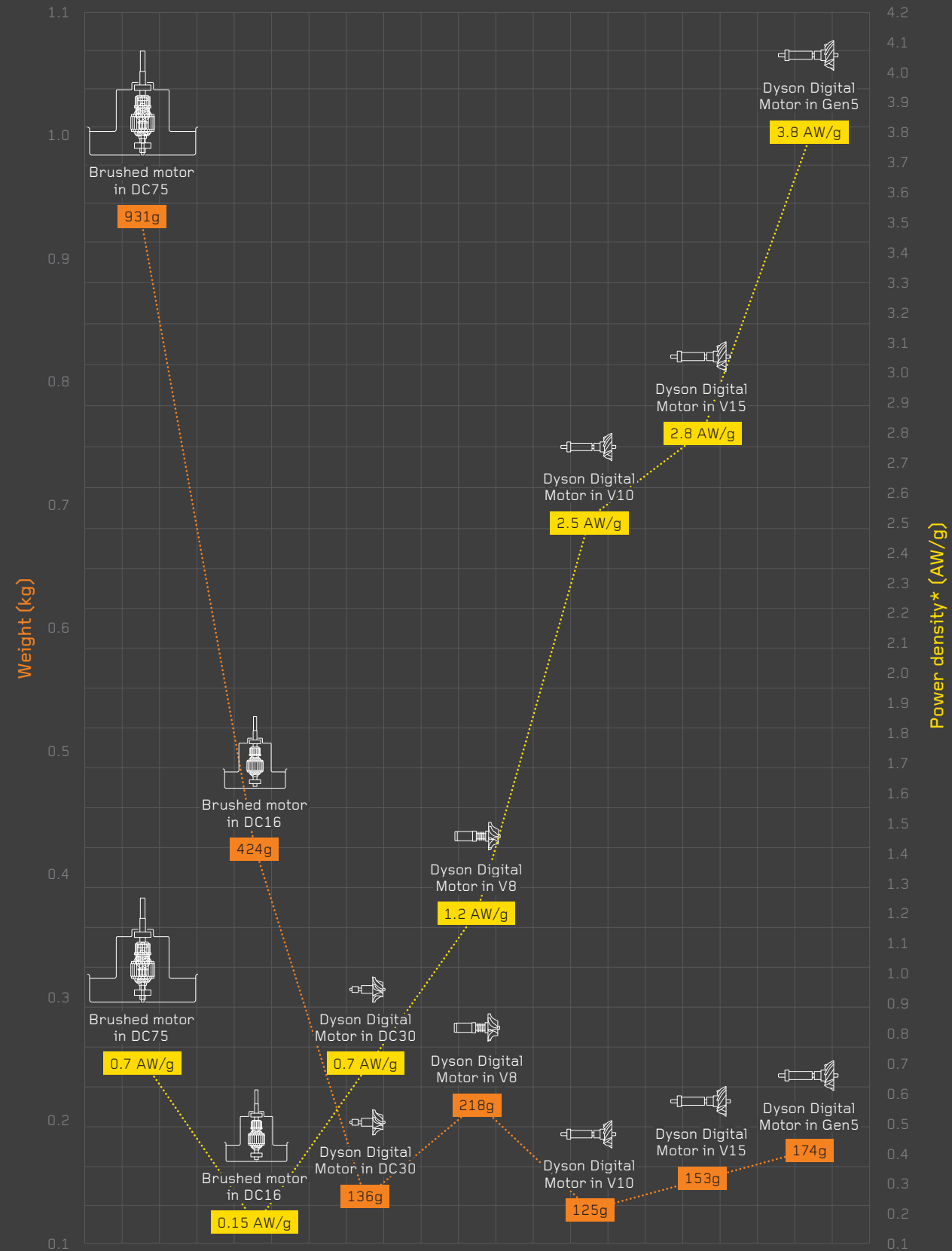

*Power density (measured in airwatts/g) is the amount of suction power a motor can produce relative to its weight. High power density = powerful and lightweight.



Materials matter

The Recyclone™, Dyson's vacuum cleaner made from recycled plastic, launched in 1997. It was created in six stages including material collection and separation, organic green pigmentation and moulding. Recycled products are now widespread, but at the time it was unusual and counterculture. The Recyclone™ was extremely durable, but rather than 'inventive' it was deemed 'second hand'.

Ever since, our materials engineering team continues to explore lightweight, innovative, and sustainable materials for future products. For example, recycled material is used in the Dyson Purifier Cool™ Formaldehyde, made from 21.5% recycled plastic by weight. Washable filters and wipeable bins in our vacuums can be reused for the lifetime of the machine, reducing waste too. And we engineer and test everything we make to maximise lifespan.

We are also focused on working towards a future where materials grown by Dyson Farming are used in Dyson products.

Less material. Engineered strength.

Dyson engineers start with the bare minimum. Rather than adding material for strength, they use intelligent design and geometry, a process called Finite Element Analysis, to predict how a product will react to real-world forces, such as vibration and heat.

Our materials engineering team is exploring new lightweight, innovative, and sustainable materials for our future products. We are using an increasing amount of recycled materials, including in parts of the Dyson Gen5detect™ vacuum and in Dyson purifiers.



8.5kg

2.61kg



Recycled magnets

The Supersonic hair dryer has clip on attachments so you can create different hair styles on different hair types. These attachments clip on to the hair dryer using magnets. We are starting to develop ring magnets with recycled neodymium – a rare earth material. These magnets contain neodymium, which is 100% recycled, alongside other metals.

Reducing standby energy use by 50%

Dyson vacuums are increasingly intelligent, using sensors, electronics and layers of software to extend run time and adjust power when needed. Onboard software in our vacuums works to communicate with the user, sharing information with you to ensure an efficient clean. Automatically increasing energy only when needed, and reducing when not.

Energy-saving software onboard the Dyson Gen5detect™ vacuum puts the machine in a deep sleep when on standby, reducing its standby energy consumption by 50% compared to its predecessor.

Dynamic Load Sensing, a smart feature, intelligently detects brush bar resistance and communicates with the motor and battery to change the suction power between carpets and hard floors – automatically increasing suction power when needed and preserving run-time and energy when you don't.



Acoustic Dust Sensing automatically adjusts power levels according to the amount of dirt present. A sensor detects the size and count of particles, increasing or decreasing suction power when needed.

A on the label
G in the home.

Testing in the real world, not just the lab.

The European Union's flawed energy labelling regulation, introduced in September 2014, misled millions of consumers.

The label exaggerated the energy efficiency of bagged vacuum cleaners because they were tested while empty, with no dust. This does not reflect real-world use. Vacuums don't stay empty. Bagged vacuums lose suction as they fill with dust, so performance drops. Some machines even compensate for this loss of power by increasing power during use – becoming far less efficient. Dyson fought hard to make sure consumers were not misled by this bad regulation.



To find a truly efficient vacuum, look beyond the label. At Dyson, efficiency goes much further than basic testing. It is defined by the relentless engineering of each component to perform well in real life conditions.

Efficient batteries

There has never been a more important time for battery technology and the need to improve both performance, efficiency and sustainability. Frustrated by the limitations of conventional lithium-ion batteries, Dyson made the decision to research, and eventually develop and manufacture, its own energy storage technologies.

Fast forward 12 years and Dyson's team of 150 scientists, engineers and technicians, focused on the research across its Singapore and UK labs, are progressing multiple generations of battery technology towards manufacture.

Unencumbered by prior investment in conventional lithium-ion battery manufacture, Dyson aims to reinvent the battery, from novel and more sustainable raw materials, through to new methods of recovering and recycling manufacturing waste and end of life. We're exploring novel recycling processes capable of recovering up to 99% of battery materials.

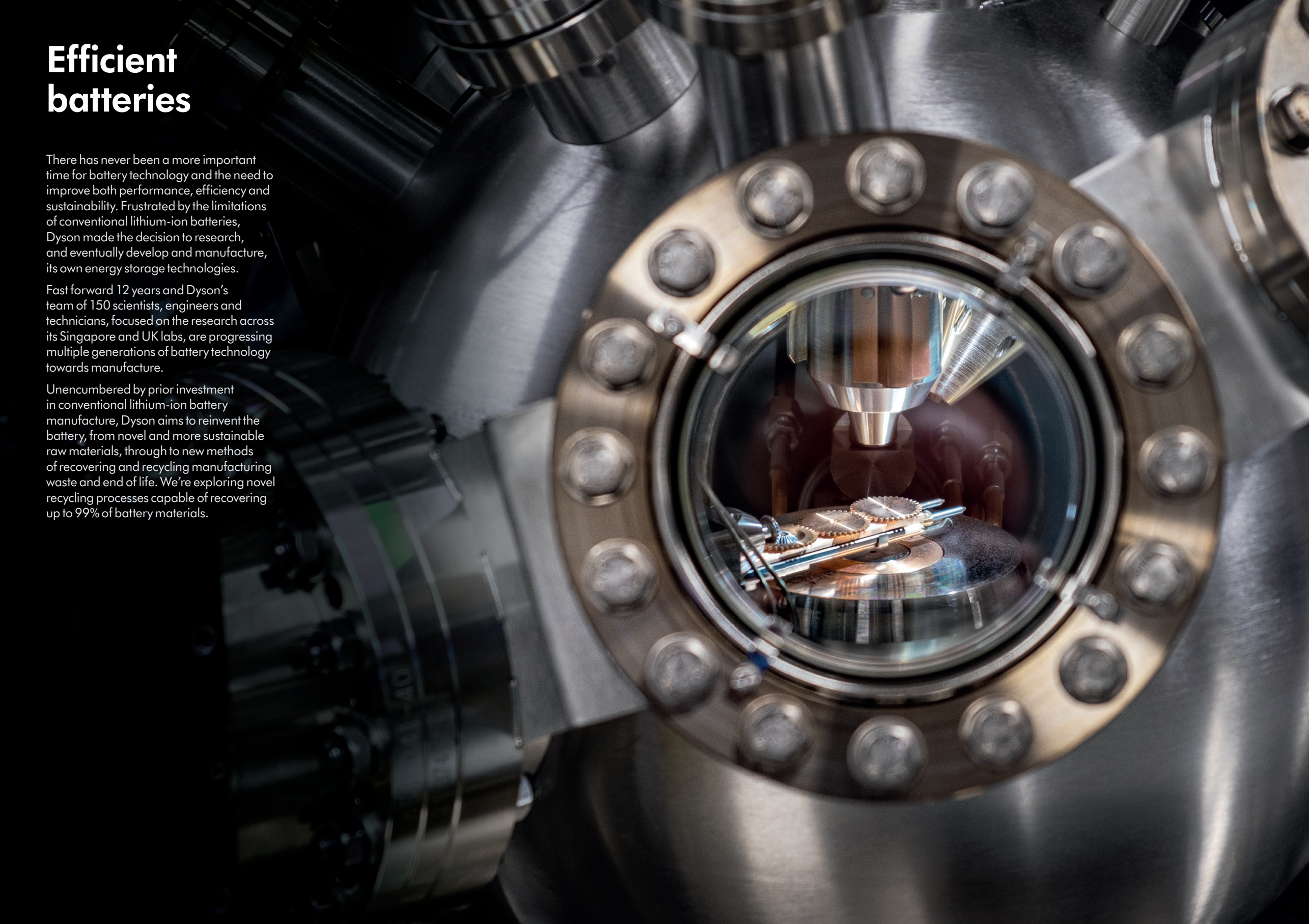

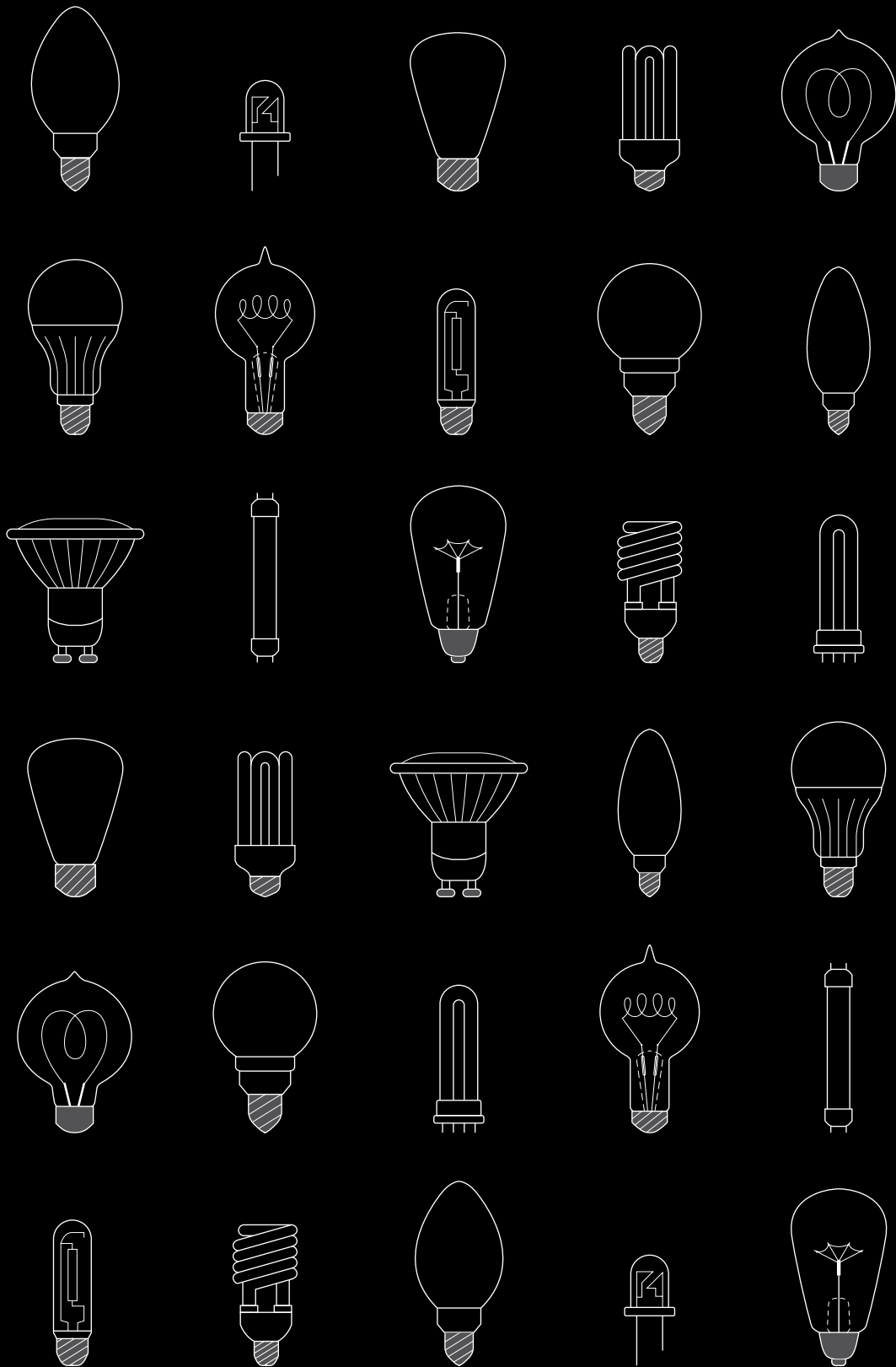

No more bulb changes. One light for life.

Too much glare. Flickering and harsh colours. Failing to fill the room. These are some of the problems that traditional lights can create, alongside the fact that their bulbs can be unreliable and need replacing often.

Dyson LEDs maintain light quality for at least 60 years and use unique local daylight tracking to deliver light throughout a room, in sync with your circadian rhythm. Dyson's Heat Pipe technology draws heat away from LEDs to provide a non-stop, energy-free cooling cycle which lengthens the life of the product.

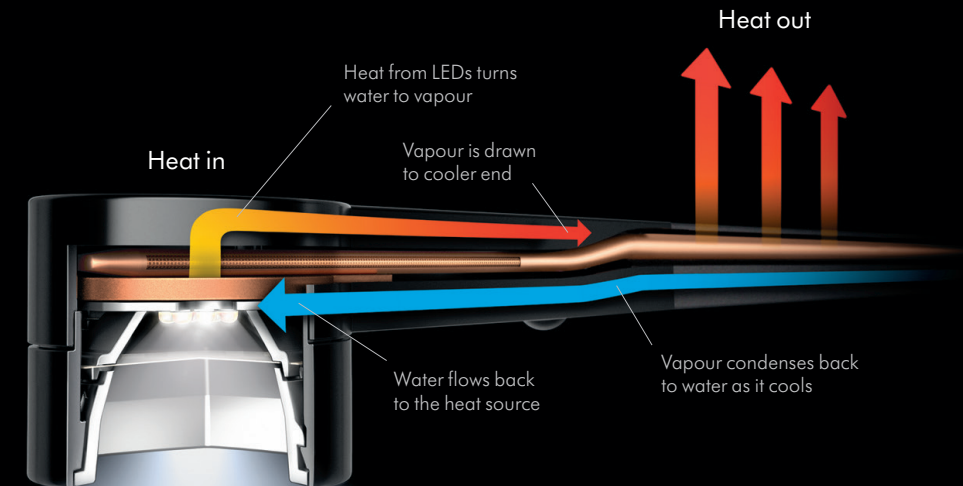



Drying hands with less waste, and less carbon

Dyson hand dryers are engineered to prioritise hygiene through touch-free design and HEPA (high efficiency particulate air) filters. These filters capture 99.95% of particles as small as 0.1 microns, including particles the size of bacteria.

In Eco mode, the Dyson Airblade™ 9kJ uses just 9.3 kilojoules of energy per dry. It is the fastest, most energy efficient, HEPA filtered hand dryer – drying hands in just 10 seconds in Max mode, and 12 seconds in Eco mode, with no paper waste.

This is good for sustainability, but also good for the businesses installing them.

Paper towels have a higher impact on the environment than some other hand drying solutions. There is a continuous cycle of tree felling, water use, alongside waste disposal and restocking.

Old-fashioned hot air hand dryers also have problems.

The Dyson Airblade™ 9kJ emits up to 88% less CO₂ and costs up to 99% less to run than paper towels.

*The environmental impact of electrical appliances and paper towels was measured by Carbon Trust. The calculations were produced using the software Footprint Expert Pro, based on product use over 5 years and using weighted averages of individual countries of use. Dry times for product were evaluated using DTM 769.



In 1993, James Dyson appeared on the BBC in the UK to show off the early prototype of a cyclonic filter that could be fitted onto a vehicle's exhaust system to trap diesel fumes.

Dyson vs diesel

In 1988, US research showed that exhaust from diesel engines was linked to premature death in laboratory mice and rats. Having read that report, in March 1990, James Dyson set Dyson engineers to work on a cyclonic filter that could be fitted on a vehicle's exhaust system to trap pollution.

By 1993, Dyson had developed several working prototypes and approached the automotive manufacturers. Their response? That disposing of the collected soot was too much of a problem. Instead, they opted to fit catalytic converters to exhaust systems, something which governments supported as they promoted diesel cars over subsequent decades.

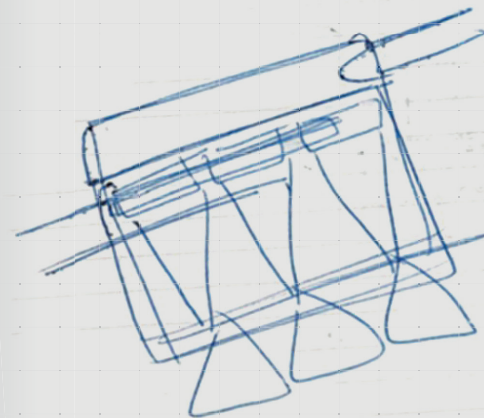
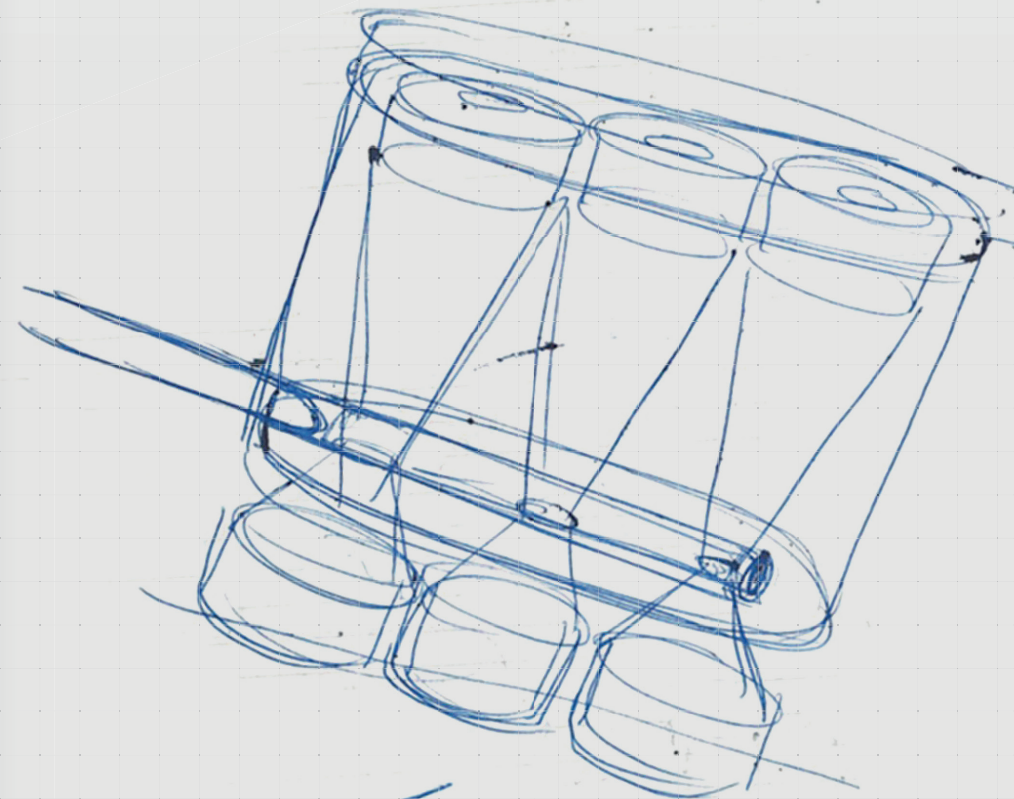

Emission

10x more than petrol
 $NO \Rightarrow NO_2$
 CO
 $SO_2 \Rightarrow H_2SO_4$
 $HC \Rightarrow$ (benzene
 Soot (poly cyclic aromatic)

Years later, when Dyson had grown its specialised teams developing batteries and motors, we returned to the problem of exhaust pollution. In 2017, Dyson started developing an electric car. Dyson engineers developed a radical electric car concept that would have solved many problems traditionally associated with electric vehicles.

Biometric sensors and infrared facial imaging

Ballistocardiography sensors use piezo technology to monitor the heart and breathing rate, humidity, and body temperature of the occupants to alleviate stress levels and tiredness whilst travelling.

Obsessive aerodynamics

The most efficient, aerodynamic vehicle form to reduce drag and provide high-speed stability.

Road pollution sensing

Diesel and petrol exhaust sensor (NO₂, CO₂), PM2.5 counter for air quality index information.

The longest real-world range

Extended 1,000km range through smart holistic energy use, with accurate range prediction.

Most efficient motor in any electric vehicle

Compact and light, yet powerful, and the only one made from Supercore™ steel. Designed to endure 20,000rpm – 20% beyond the standard threshold.

A smoother, quieter ride

The largest 600mm wheels that can be changed at a tyre depot, and patented, narrow width tyres to significantly reduce rolling drag.

The purest, healthiest cabin air

Purified, sealed and pressurised cabin with class-leading 99.9995% filtration. Intelligently detects and removes hydrocarbons, NO₂ pollution and allergens.

Pollutant absorbing materials

The use of wool inside the car would absorb and lock away pollutants, such as VOCs, from the air.

Radiant seat heating

Panels situated in seats, doors, armrests, the steering wheel, and floor pads provide heat without airflow noise. They're controlled more accurately and reach desired temperature much faster than air vents.

Largest battery pack of any ESUV

Unique, space efficient, flat double stack of 8,000 lithium-ion cells for 150kW output. A glycol cooling plate 'sandwich filling' cools the whole system – including the motors and gearbox.

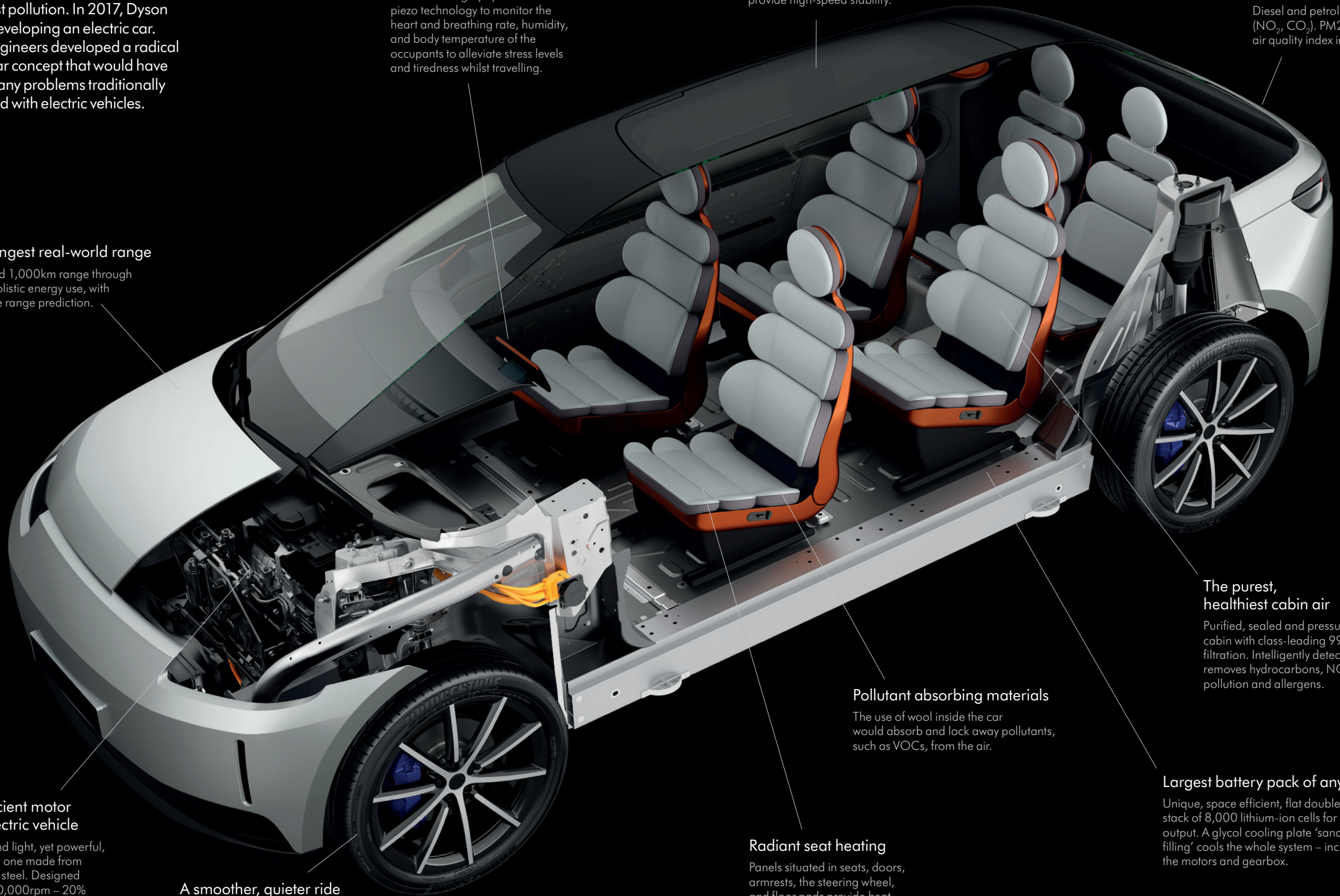

Understanding global air quality, inside and out

In October 2020, we investigated air quality in Delhi, recording data using our prototype air quality backpack. This graph shows an individual's personal exposure to different pollutants during a single day.

Over the last decade Dyson has been researching indoor and outdoor air quality. Dyson's researchers and its Scientific Advisory Board support research bodies and advance global understanding of air quality.

In 2019, Dyson developed a connected air quality backpack for the Breathe London Wearables project. School children across London wore the backpack fitted with particle and gas sensors, GPS and a battery pack to monitor their pollution exposure to and from school.

31% of participating children changed their commute to minimise exposure to pollution.

The study has since been repeated in cities worldwide, including Undergraduate Engineers at the Dyson Institute testing the backpack across Paris. The smart backpacks are currently being used across sub-Saharan African countries too: Ghana, Malawi, Nigeria, South Africa, Tanzania, Uganda and Zimbabwe, as part of the Children's Air Pollution Profiles in Africa project, to understand asthma rates among African children.

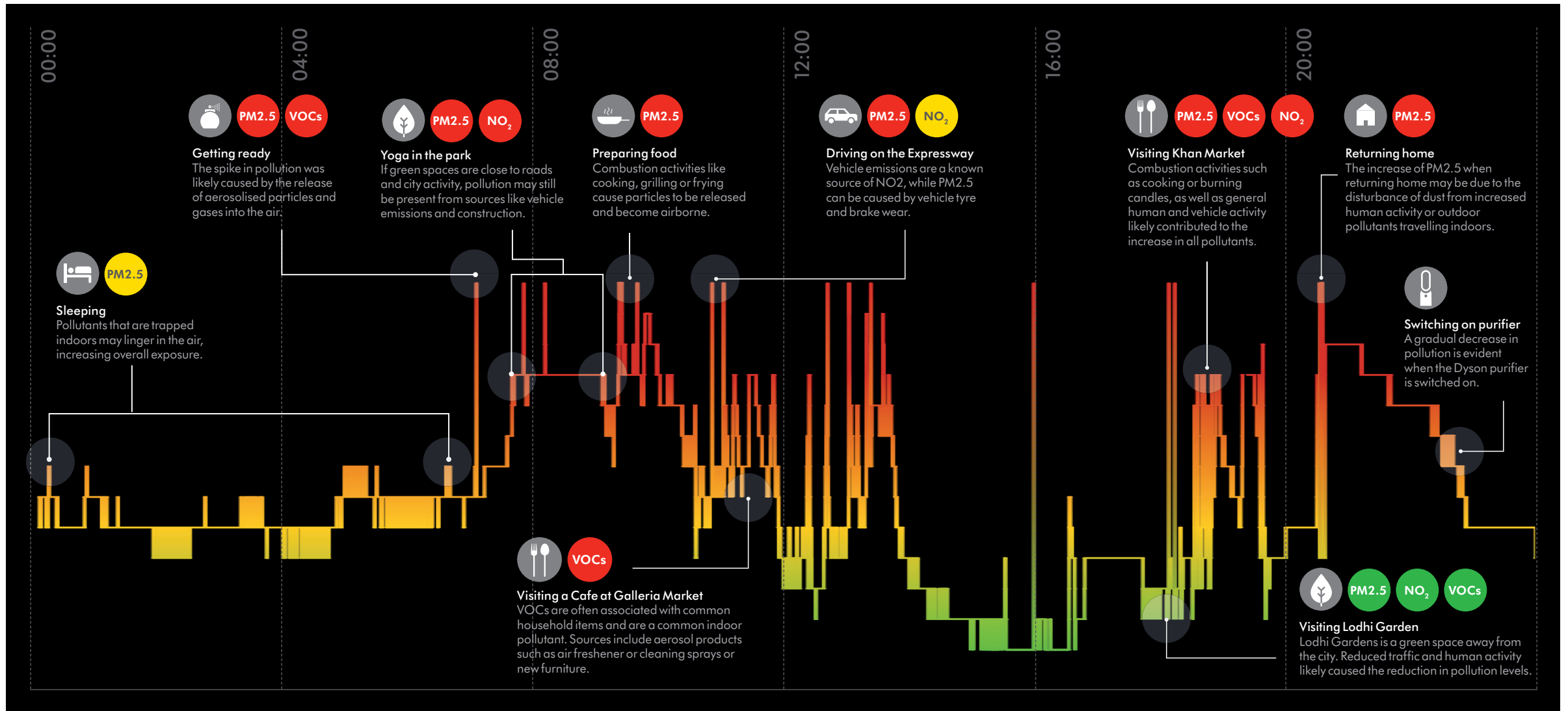

Revealing and capturing air pollution with our connected purifiers

Dyson engineers use the data sensed by more than 4 million connected Dyson purifiers to map indoor air quality worldwide. A live track of connected machines means Dyson can see pollution events occurring and its purifiers can alert people to their exposure to them.

Dyson purifiers alert people about pollution events in their local areas, based on the 200 million air quality signals sent from our purifiers each day. This informs the research and development of new purifying technology.



HEPA H13 filter



Bacteria and mould spores

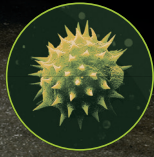

Pollen and allergens



PM2.5

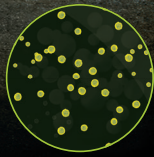

PM0.1

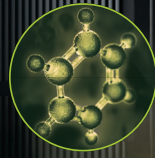
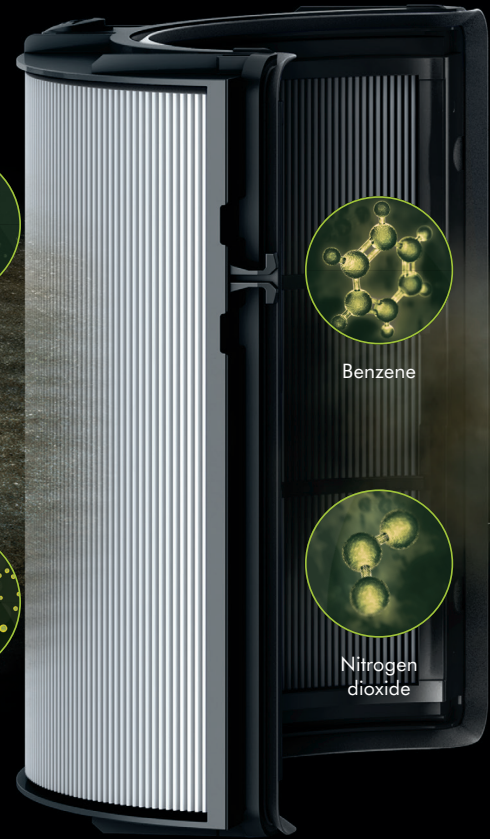

Benzene

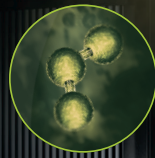

Nitrogen dioxide



Odours and household fumes

Activated carbon filter

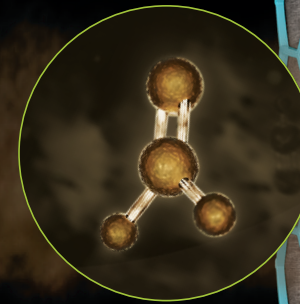
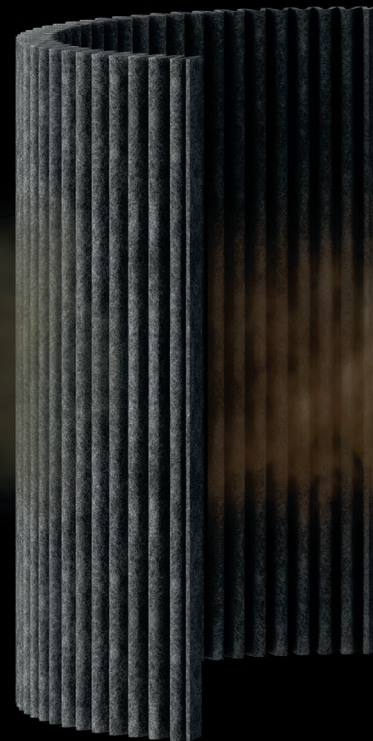

Formaldehyde

Dyson's catalytic filter continuously converts formaldehyde into water and CO₂ – and never needs replacing.

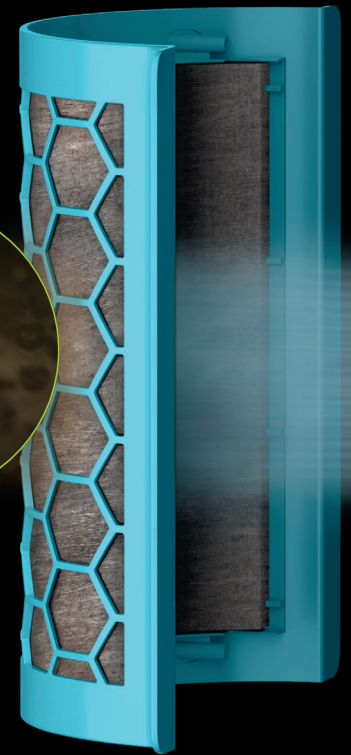

Filter frames made from 85% recycled plastic

Dyson air purifiers have multiple sensors that detect pollutants in the air, before filtering them in two or three stages. A HEPA filtration system captures particles, such as dust, pollen, viruses and bacteria, while an activated carbon layer removes gases and odours. In some of our purifiers, a selective catalytic oxidation filter removes and destroys formaldehyde. The Dyson Purifier Cool™ Formaldehyde is made from 21.5% recycled plastic by weight, and our latest filter frames contain 85% recycled plastic.



Delivering pure air, anywhere

As well as delivering high-fidelity audio – music and sounds as the artist intended – Dyson Zone™ headphones will use purifying technology to monitor and clean the air in your personal space.

They are Dyson's next step, entering the world of audio technology and wearables, taking the high-quality filtration performance our machines offer to users on-the-go.

The Dyson Zone™ is also connected. Using the MyDyson™ app will provide real-time air quality and noise pollution data, and weekly pollution trend reports, helping our owners understand how they can reduce their exposure to pollution.

Tested to survive real life.

Making things last for as long as possible reduces the need for them to be replaced. Dyson products are built to last and are engineered and rigorously tested for durability.

During development, each product will be dropped onto a hard floor over 5,000 times and cover 1,000km of flooring in push-pull tests. Cumulatively, new designs will be subjected to 500,000 cleaner head joint swivel tests, charging and discharging batteries up to 6,000 times, and running digital motors for up to 20,000 hours. Prototypes are dropped from over two metres in different orientations and powered up to ensure there has been no detectable drop in performance.

It takes around 120 Dyson engineers 50,000 hours to be satisfied a product is tough enough, testing to the point of failure.



Then given a second life.

Refurbished Dyson machines that have been quality tested and inspected, and use genuine Dyson replacement parts, can be bought on the Dyson website. Dyson also sells refurbished machines on official outlets via third party marketplaces, like eBay.

Dyson is built on sustainable principles. We are led by engineers, and their approach – to do ‘more with less’ – has been evident in our products and technology, from the first Dyson vacuum cleaner, the DC01, right through to our future product pipeline.

Our sustainable principles are not just in what we make. It’s also in the buildings we restore to use for our research and development. Our charitable work is important to us too, including the James Dyson Foundation and James Dyson Award, which encourage young people to solve the problems of our time. And we use sustainable practices in how we produce food, using the latest agriculture technology at Dyson Farming.

This is the first of four installments that will summarise our approach to sustainability, and where we will go next.

To follow:

Renew: Buildings and manufacturing

Reshape: Education and medical research

Reimagine: Dyson Farming

dyson